

CONERO

Inside Pullout 168 H 475

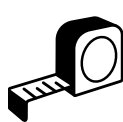

<http://support.kesseboehmer.de>

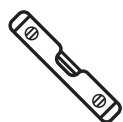
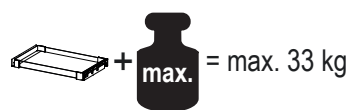
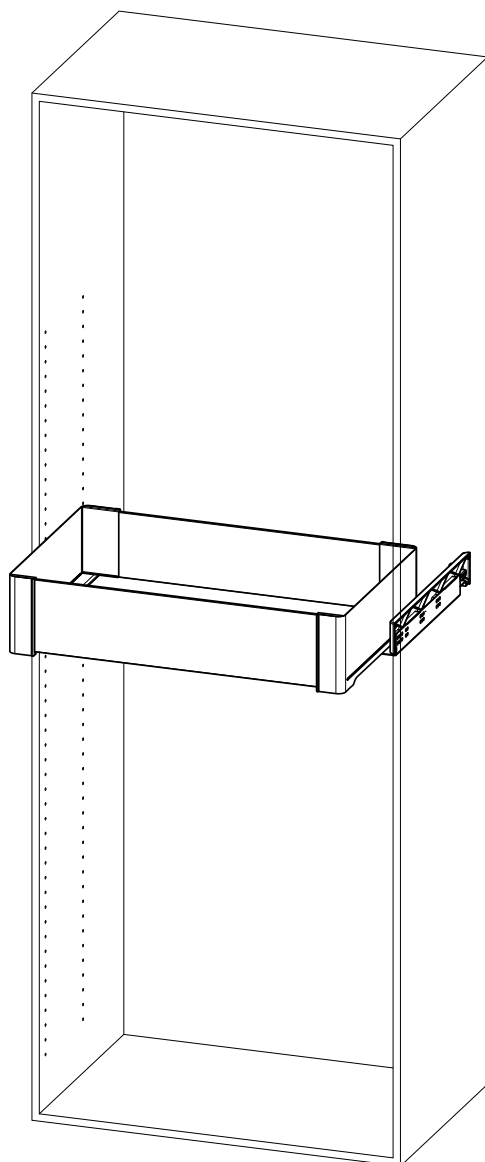
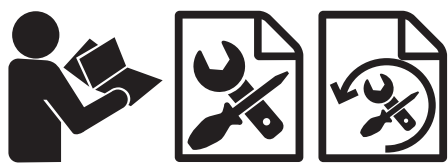

CONERO

Inside Pullout 168 H 475



mm
(inch)

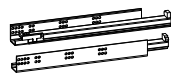

1x

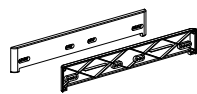

1x

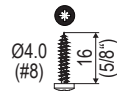

8x

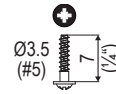

6x

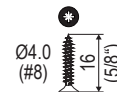

10x

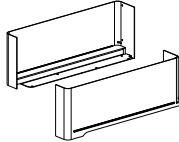

1x



1x



1x



4x

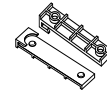

8x



1x

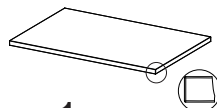

1x

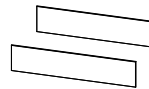

1x



optional

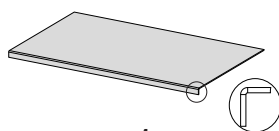

1x

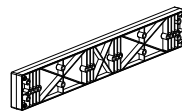

1x - 4x

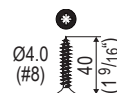

5x - 10x

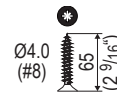

7x - 14x

DE Die technischen Darstellungen und Maßangaben – auch bei Abbildungen und Zeichnungen – sind unverbindlich. Konstruktionsverbesserungen sind vorbehalten! **EN** Technical information and stated dimensions (including in illustrations and drawings) must not be regarded as binding. Design subject to improvement without notice! **FR** Les visuels techniques et dimensions – y compris les schémas et les illustrations – ne sont pas contractuelles. Sous réserve d'évolutions techniques! **IT** Le rappresentazioni tecniche e le indicazioni delle dimensioni – anche nelle figure e nei disegni – non sono vincolanti. Con riserva di miglioramenti di progettazione! **ES** Las imágenes técnicas y las indicaciones de medidas – también en imágenes y dibujos – no son vinculantes. Queda reservado el derecho de realizar mejoras en el diseño! **PT** Representações técnicas e dimensões – mesmo em ilustrações e desenhos – não são vinculativas. Reservado o direito a melhorias construtivas! **HE** כל התרשימים הטכניים והמידות – אף לגבי איורים ותכניות – הנם בלתי מחייבים. זכות לשינויים ושיפורים מבניים שמורה ליצרן! **FI** Tekniset piirroksat ja mitat – myös kuvissa ja piirroksissa olevat – ovat sitoumuksetta parantaviin muutoksiin pidätettään! **DA** De tekniske illustrationer og målangivelser – også på illustrationer og tegninger – er ikke bindende. Forbehold for designforbedringer! **CS** Technické popisy a rozměry, jakož i obrázky a výkresy, jsou nezávazné. Vyhrazujeme si právo na změny konstrukce! **PL** Prezentacje techniczne i wymiary – także na ilustracjach i rysunkach – nie są wiążące. Udoskonalenia konstrukcyjne są zastrzeżone! **RU** Иллюстрации технических деталей и указанные размеры, в том числе на рисунках и чертежах, являются ориентировочными. Компания оставляет за собой право на усовершенствование конструкции! **TR** Teknik sunum ve ölçü bilgileri (resim ve çizimlerde de) yasal olarak bağlayıcı değildir. Yapısal geliştirmeler yarma hakkı saklıdır! **BG** Техническото представяне и размерите, включително при изображенията и чертежите, са необвързващи. Запазваме си правото на конструктивни подобрения! **HU** A műszaki ábrázolások és méretadatok – ábránál és rajzoknál sem – nem kötelező érvényűek. A konstrukciós javítások joga fenntartva! **SR** Tehničke ilustracije i dimenzije – uključujući ilustracije i crteže – nisu obavezujući. Dizajn poboljšanja su rezervisana! **EL** Τα τεχνικά σχέδια και οι διαστάσεις – ακόμα και σε απεικονίσεις και σχέδια – δεν είναι δεσμευτικά. Με την επιφύλαξη τεχνικών βελτιώσεων! **AR** الرسومات التوضيحية والأبعاد الفنية – مما في ذلك الرسومات التوضيحية والرسومات – ليست إلزامية. الحق محفوظ في إجراء تحسينات هيكلية! **JA** 生みにくさが高じれ **ZH** 技术说明和规格, 包括插图和图纸均不具约束力。保留改进设计的权利!

CONERO

Inside Pullout 168 H 475



1

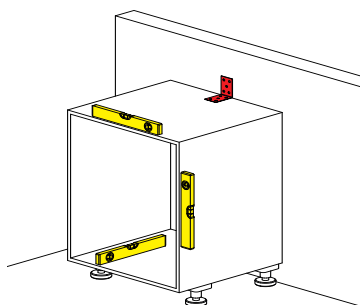

2

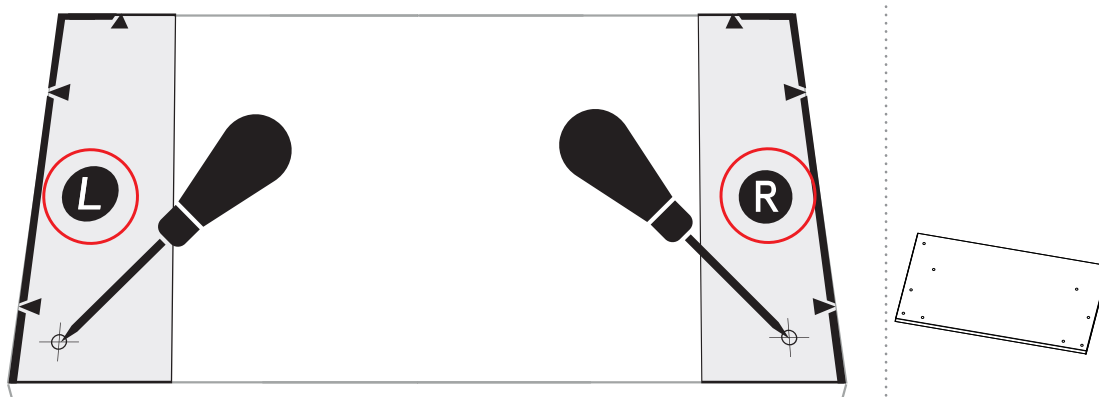
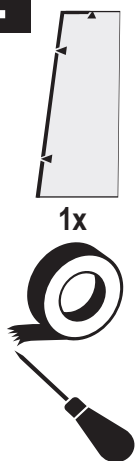

3a

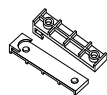

8x

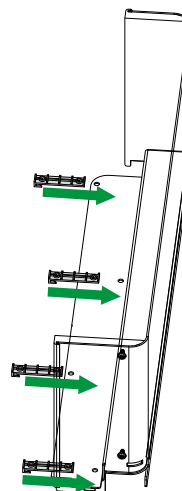
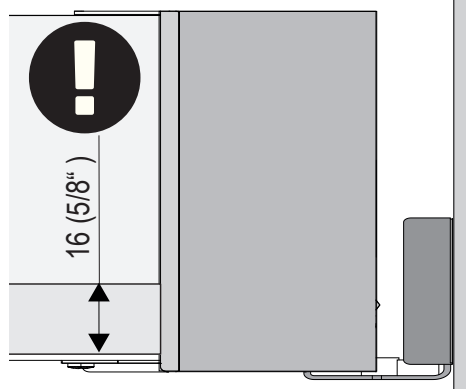

3b

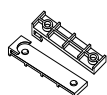

8x

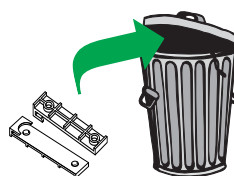
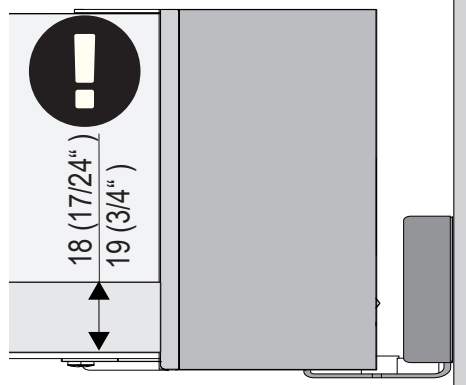

CONERO

Inside Pullout 168 H 475



4

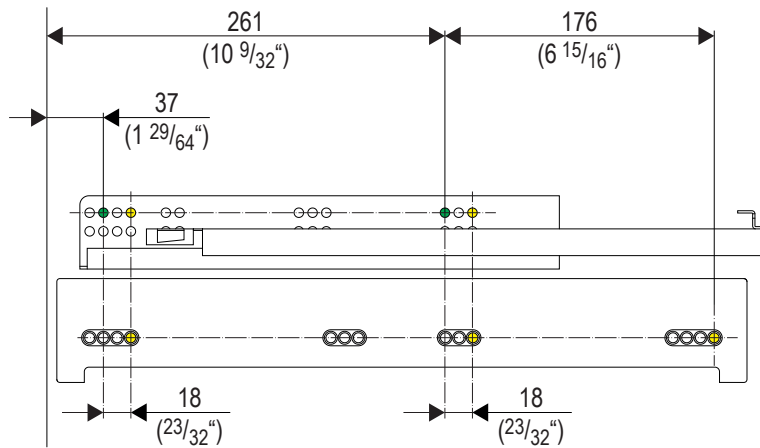
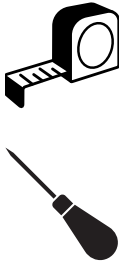

4a.1

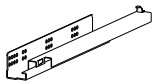

1x



PZ2

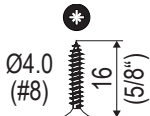

2x

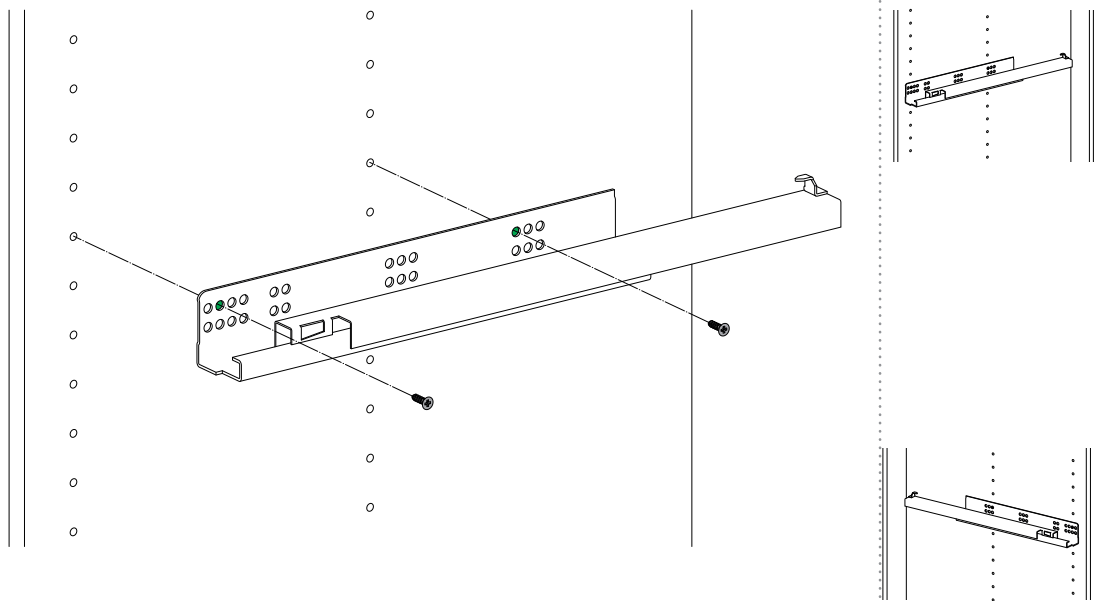

4a.2

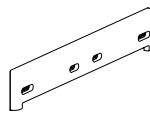

2x



PZ2

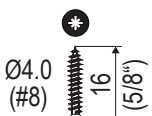

3x

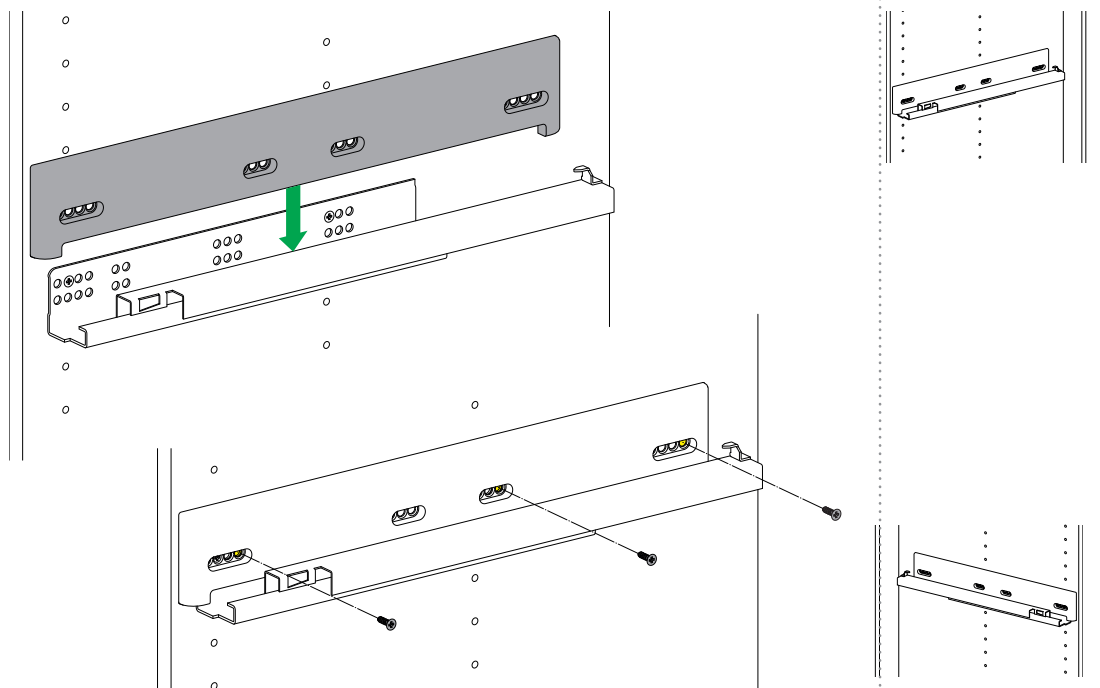

CONERO

Inside Pullout 168 H 475



4b.1

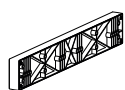

1x

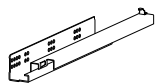

1x



PZ2

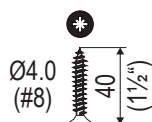

2x

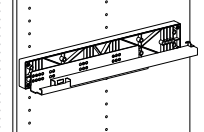
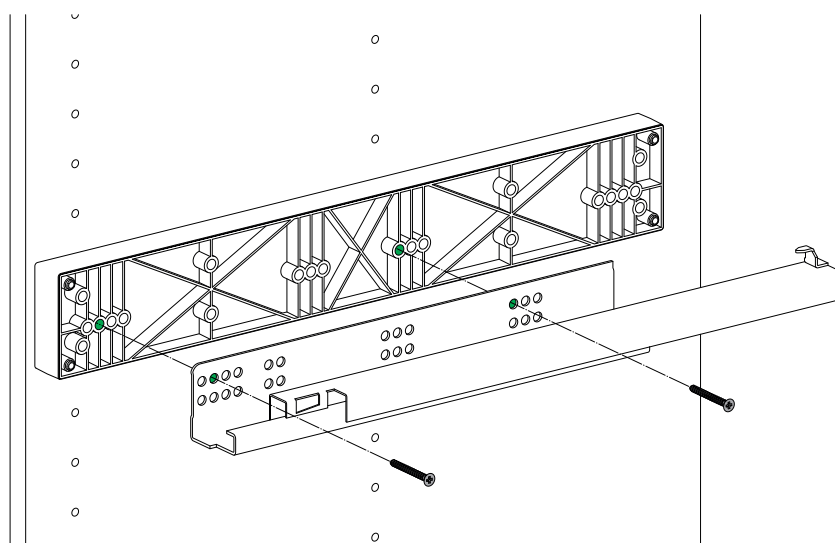

4b.2

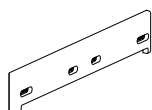

2x



PZ2

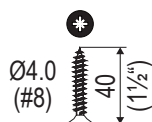

3x

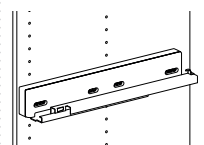
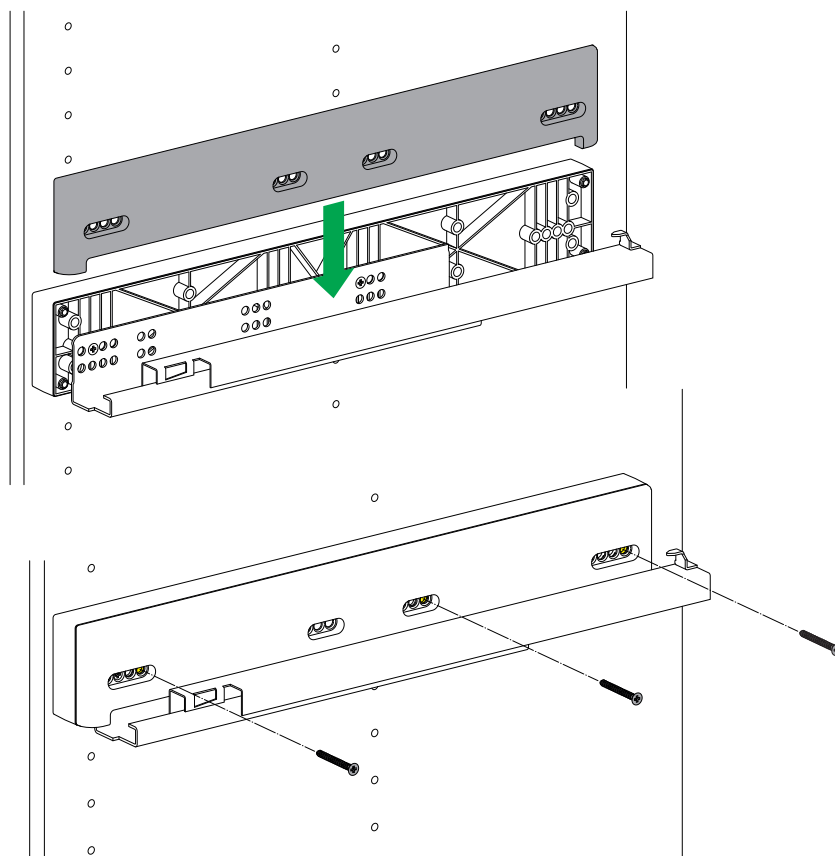

CONERO

Inside Pullout 168 H 475



4c.1

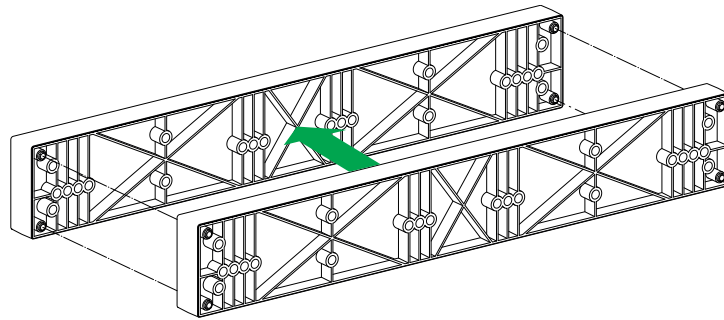
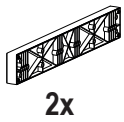

4c.2

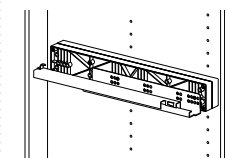
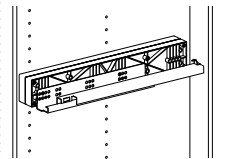
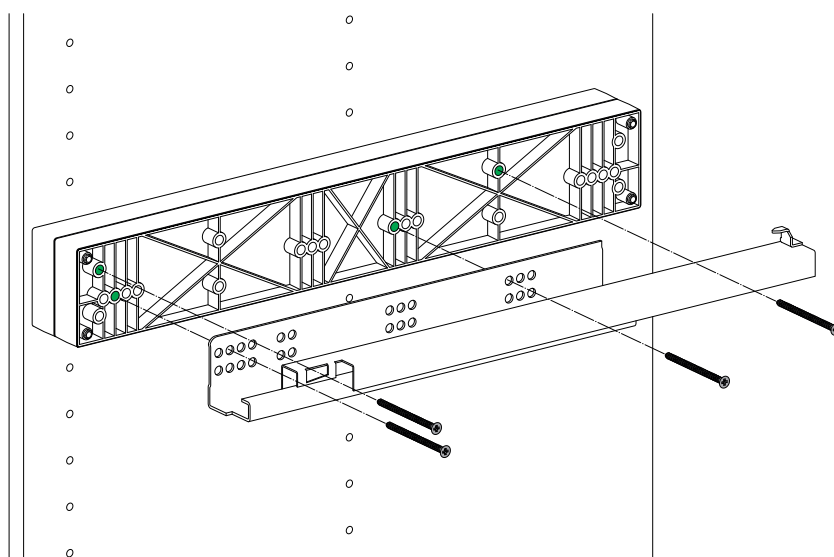
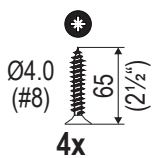
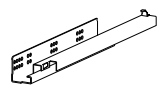
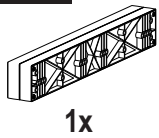

4c.3

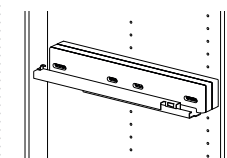
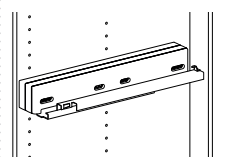
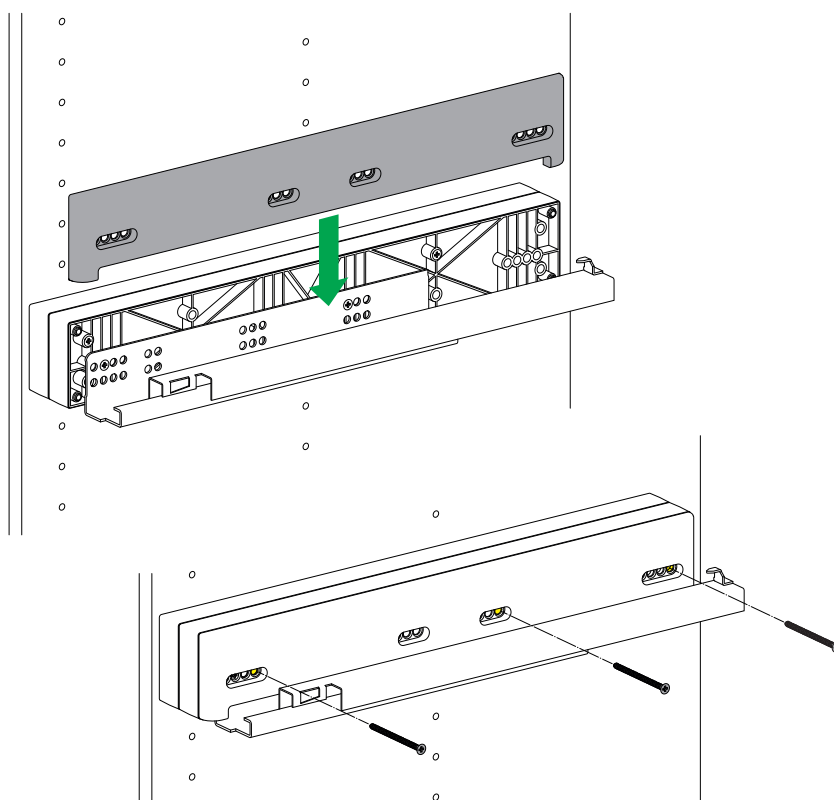
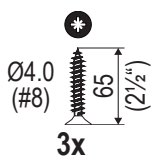
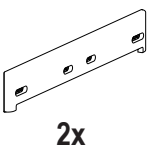

CONERO

Inside Pullout 168 H 475



5

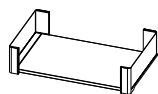

1x

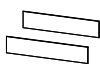

1x



1x



1x

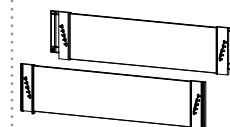
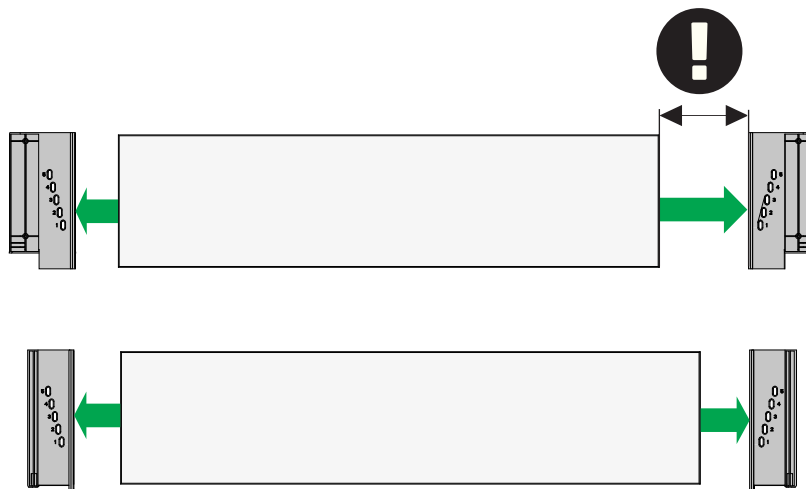

6

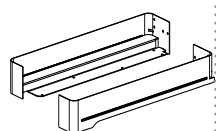

1x



1x

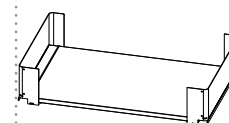
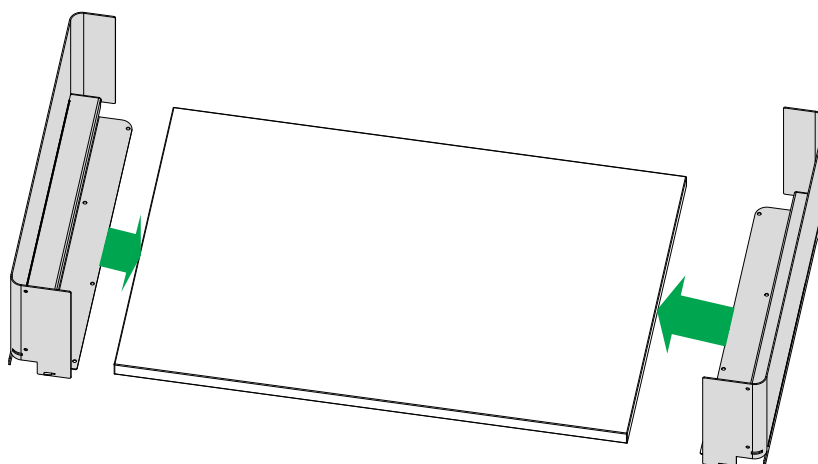

CONERO

Inside Pullout 168 H 475



7.1

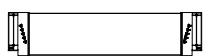

1x

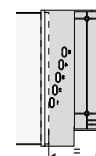
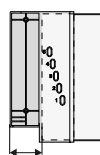
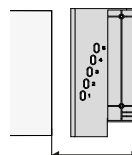
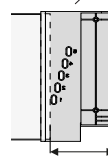
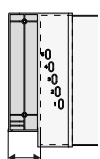
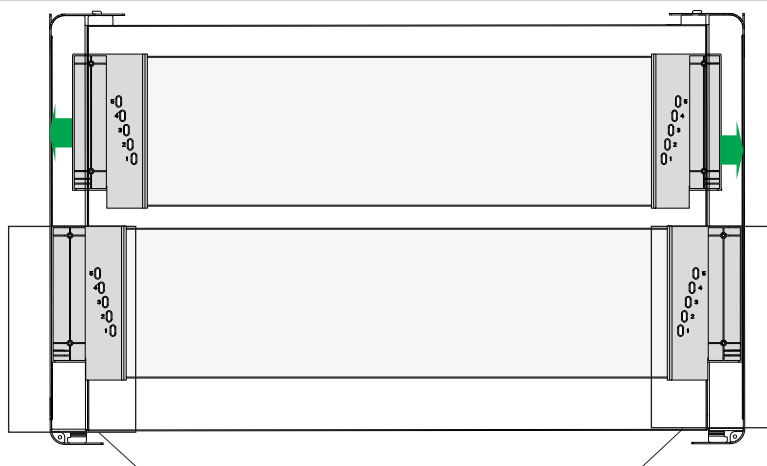

7.2a

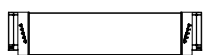

1x



2x

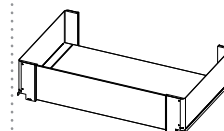
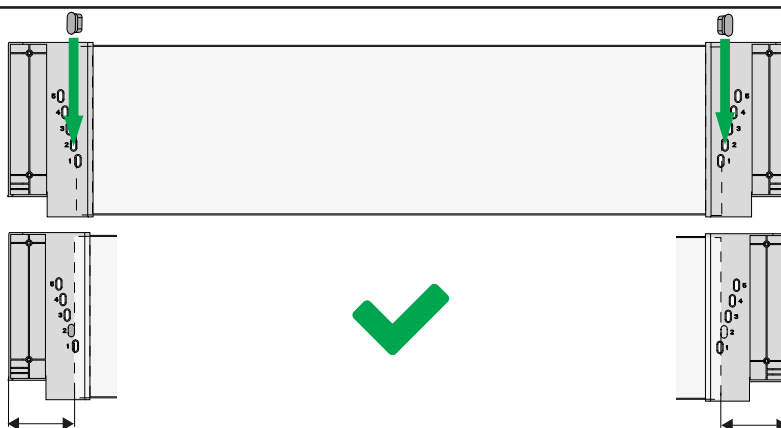

7.2b



2x

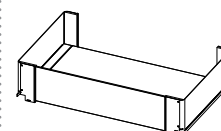
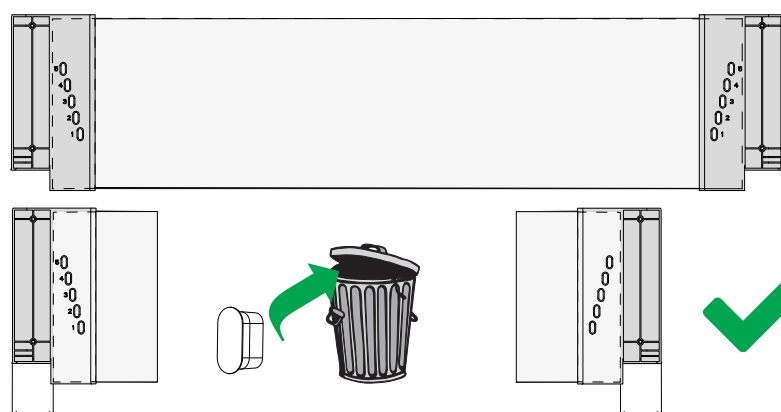

CONERO

Inside Pullout 168 H 475



8.1

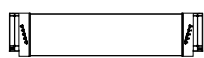

1x

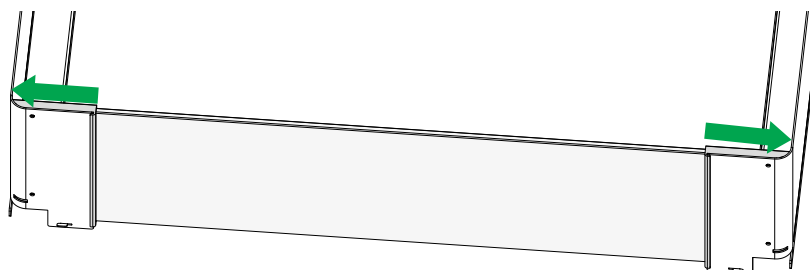

8.2

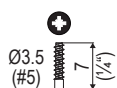

4x

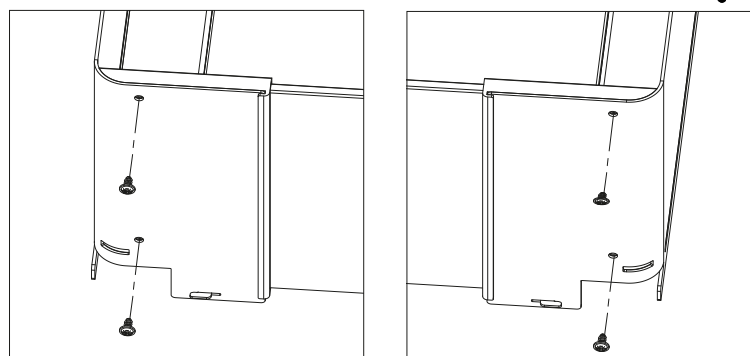
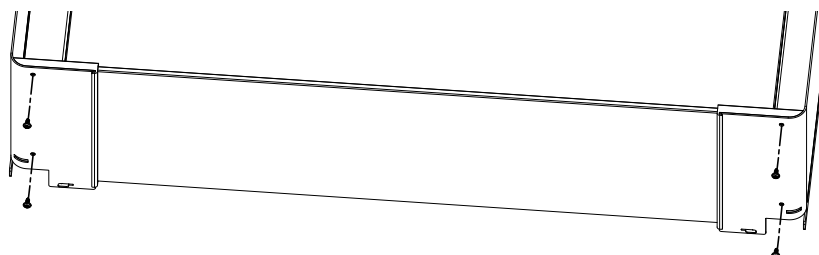

9.1

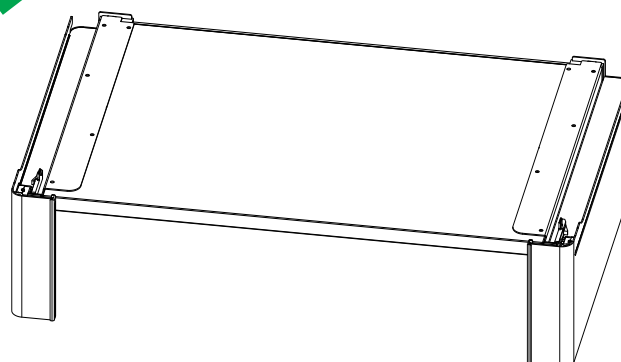
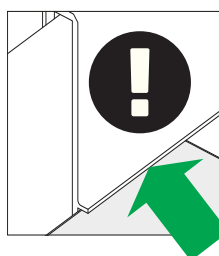
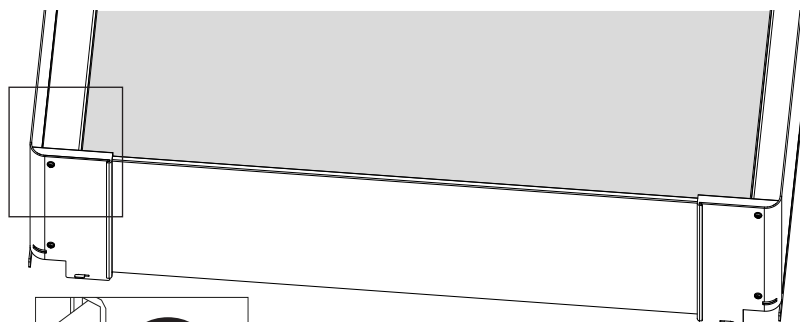

CONERO

Inside Pullout 168 H 475



9.2

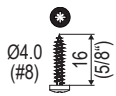

1x

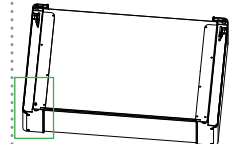
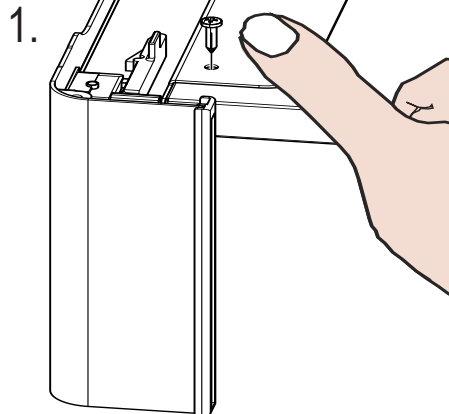

9.3

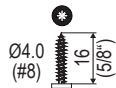

1x

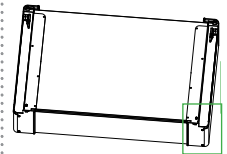
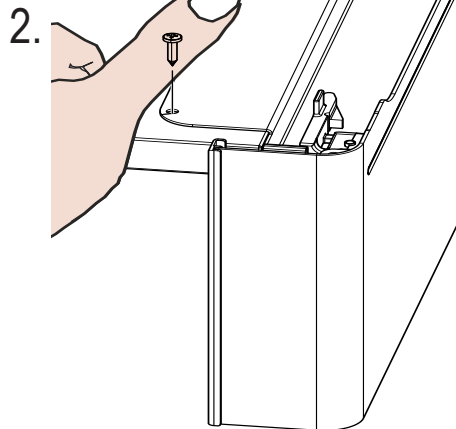

9.4

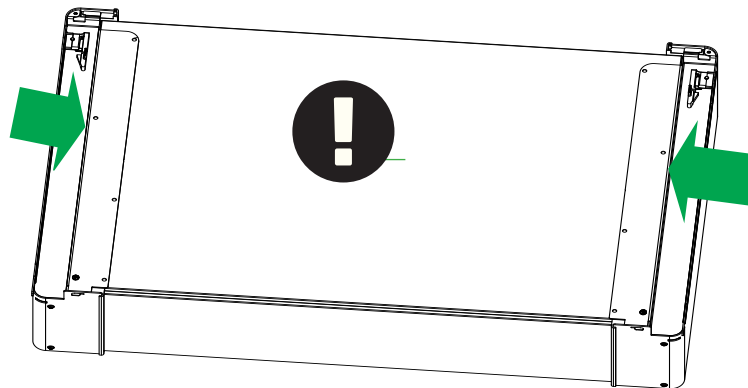

9.5

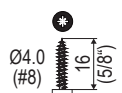

6x

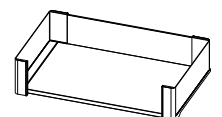
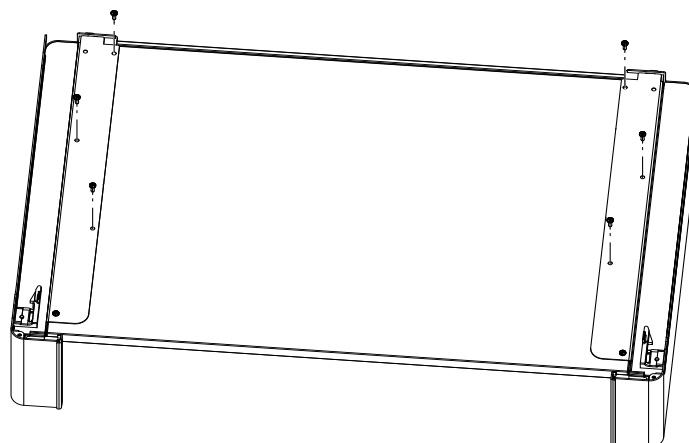

CONERO

Inside Pullout 168 H 475



10.1

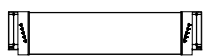

1x

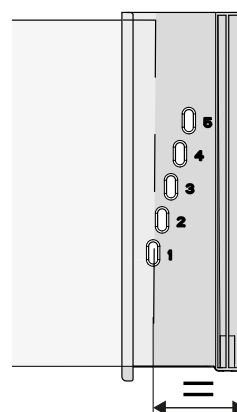
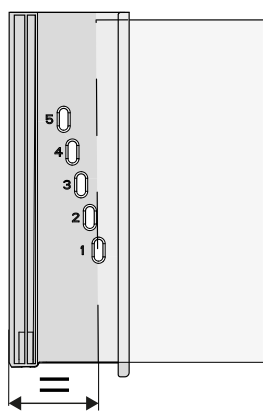
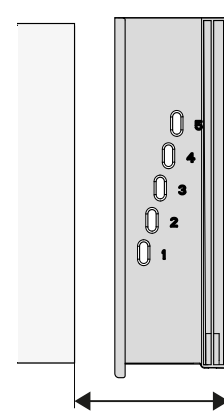
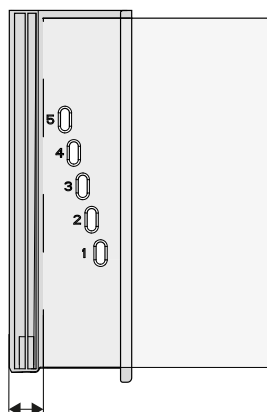
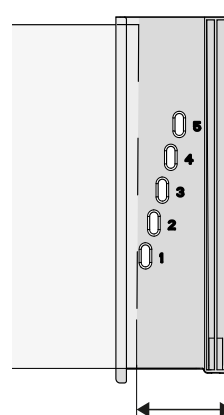
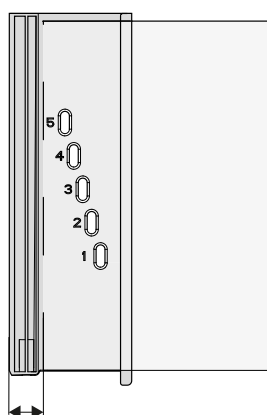
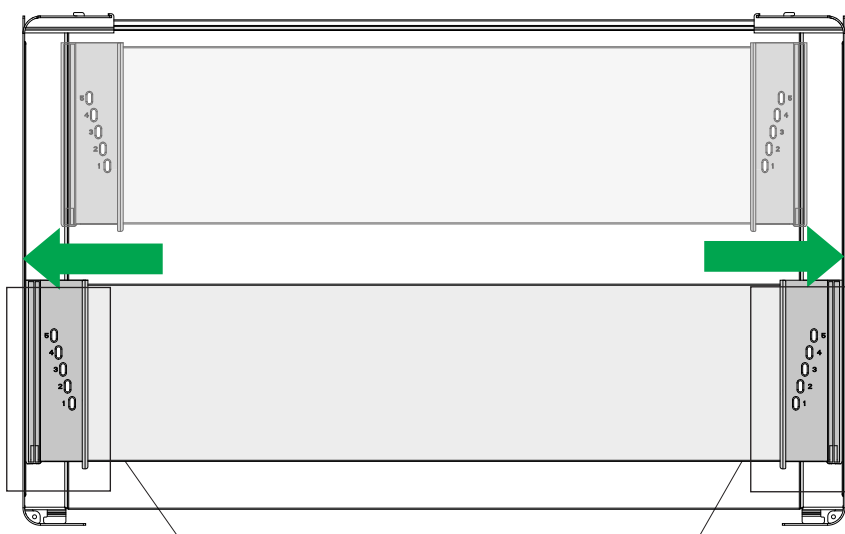

CONERO

Inside Pullout 168 H 475



10.2a



2x

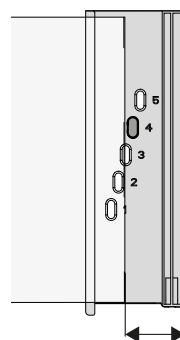
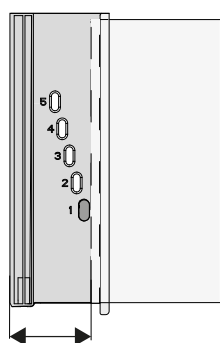
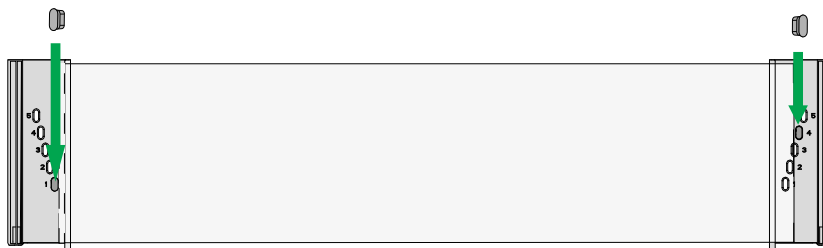

10.2b



2x

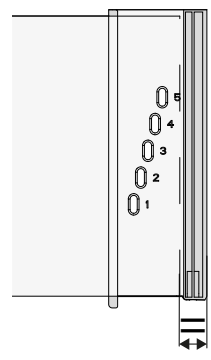
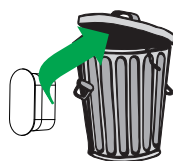
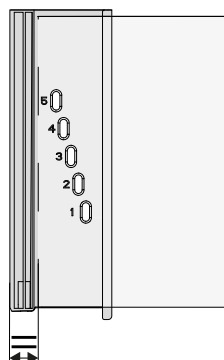
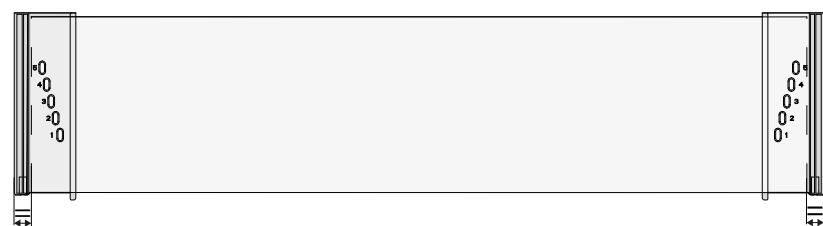

CONERO

Inside Pullout 168 H 475



11

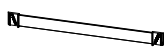

1x

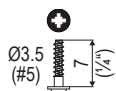

2x

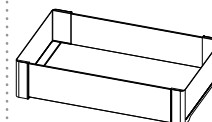
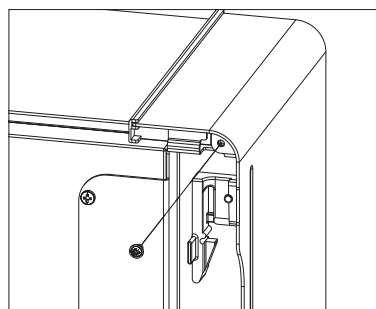
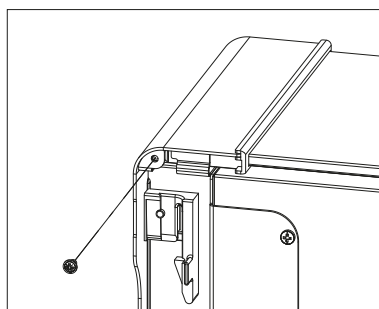
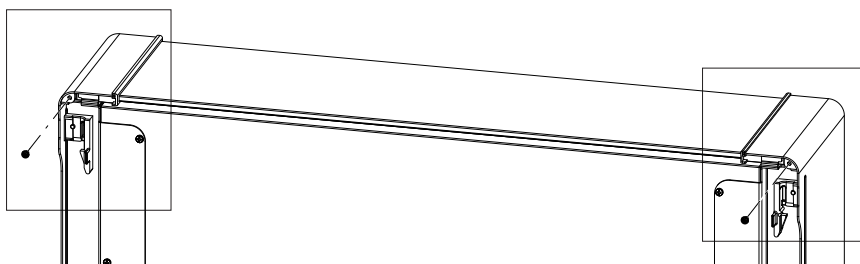
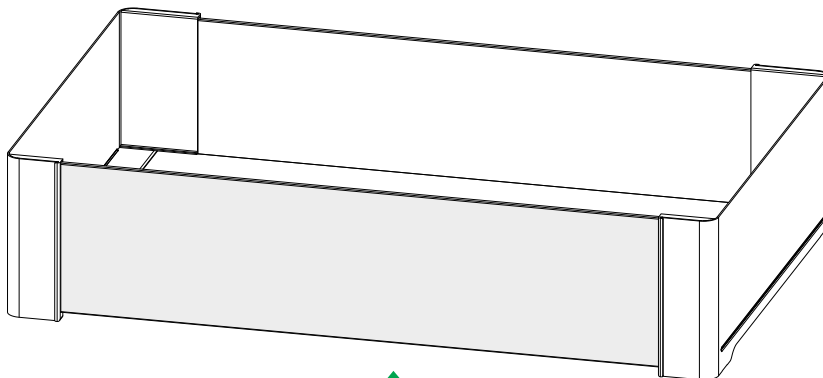

CONERO

Inside Pullout 168 H 475



12

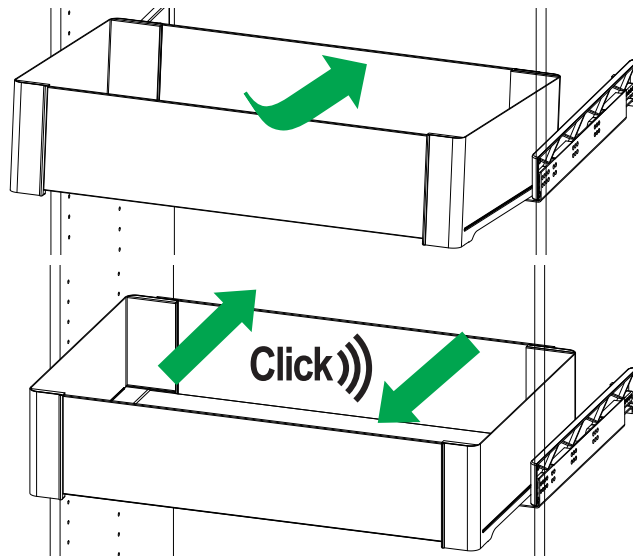

13.1

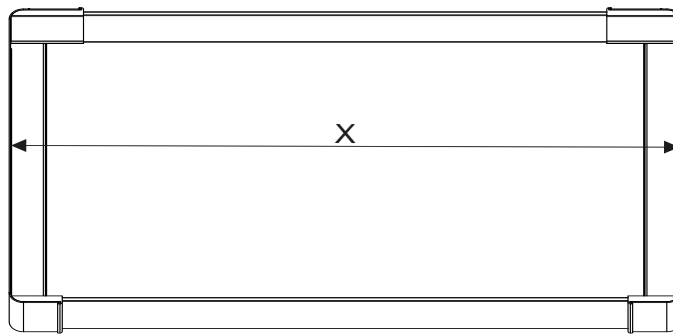
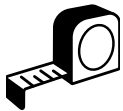

13.2



optional

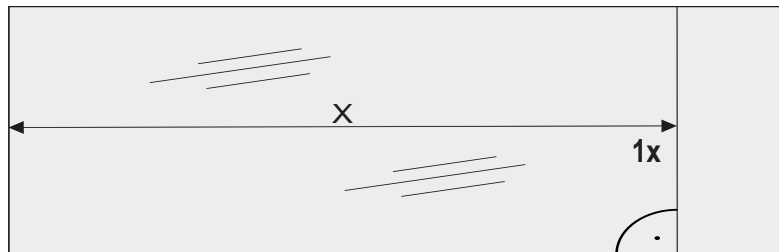
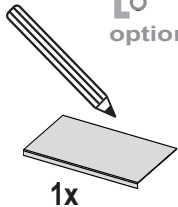

13.3

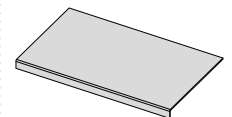

13.4



optional

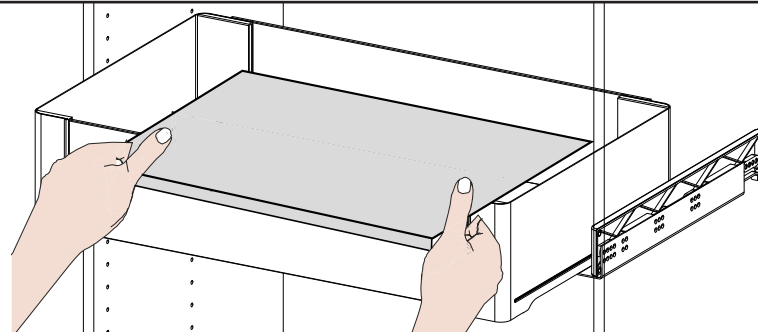
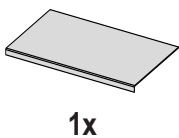

CONERO

Inside Pullout 168 H 475



i

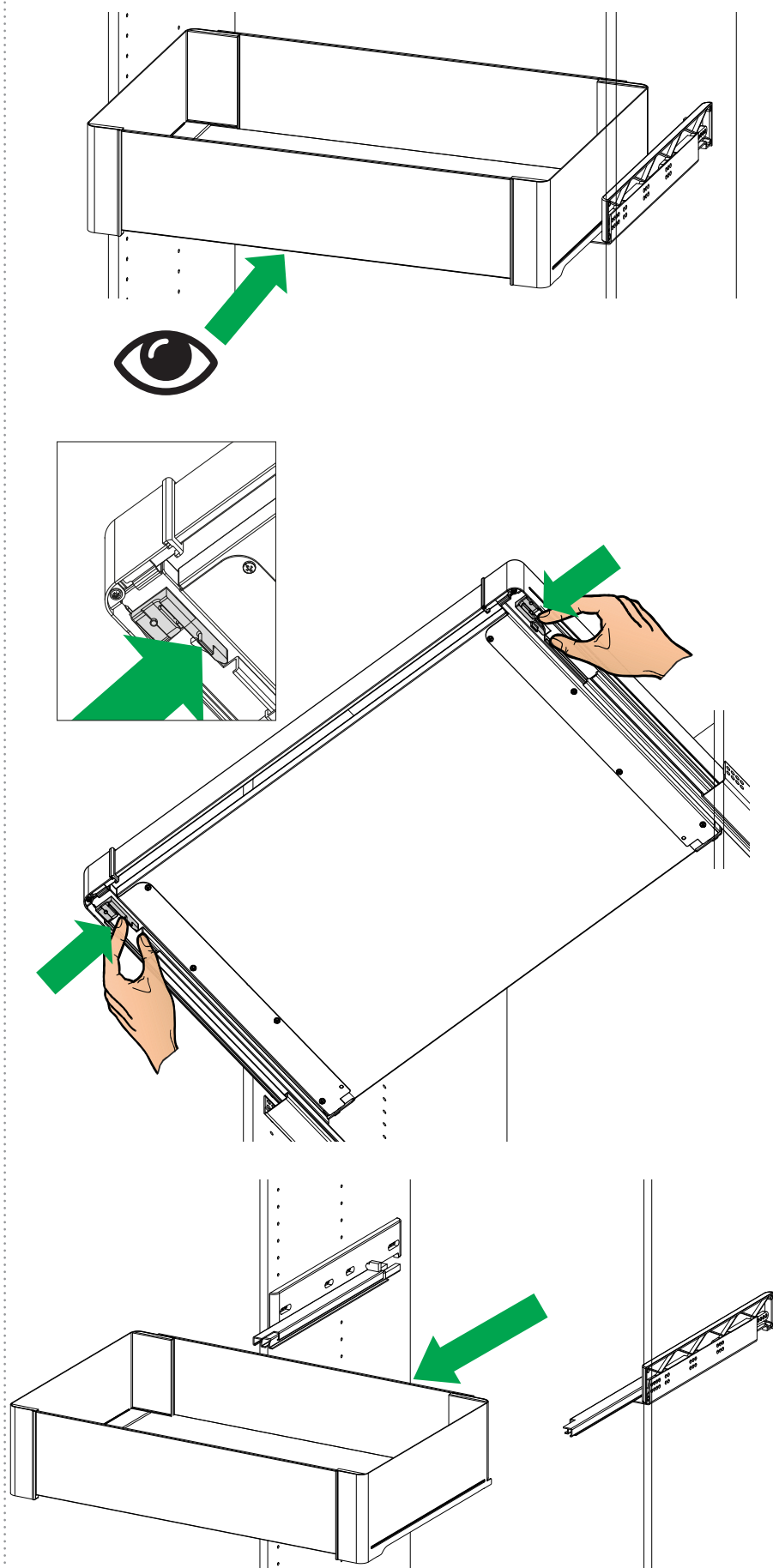

CONERO

Inside Pullout 168 H 475



i

mm
(inch)

